

EMC Test Report

Application No. : HX211011066501
Applicant : Xingzhiguang Tech (Shenzhen) Co., Ltd.
Equipment Under Test (EUT)
EUT Name : Dog Training Collar
Model No. : DOG
Serial No. : See Page 3
Trademark : N/A
Receipt Date : 2021-10-29
Test Date : 2021-10-29 to 2021-11-04
Issue Date : 2021-11-04
Standards : EN 55032: 2015/A1: 2020
EN 55035:2017/A11:2020
Conclusions : **PASS**

In the configuration tested, the EUT complied with the standards specified above. The EUT technically complies with the 2014/30/EU directive requirements

Test/Witness Engineer : *Tim Chen*
Approved & Authorized : *Andy Zhang*



This report details the results of the testing carried out on one sample. The results contained in this test report do not relate to other samples of the same product. The manufacturer should ensure that all products in series production are in conformity with the product sample detailed in the report.

TABLE OF CONTENTS

1. General Information.....	3
1.1. Client Information.....	3
1.2. General Description of EUT (Equipment Under Test).....	3
1.3. Block Diagram Showing The Configuration of System Tested.....	3
1.4. Description of Support Units.....	4
1.5. Performance Criterion.....	4
1.6. Test Facility.....	4
2. TEST Results Summary.....	5
3. Test Equipment Used.....	6
4. Conducted Emission Test.....	8
4.1. Test Standard and Limit.....	8
4.2. Test Setup.....	8
4.3. Test Procedure.....	8
4.4. Test Condition.....	9
4.5. Test Data.....	9
5. Radiated Emission Test.....	14
5.1. Test Standard and Limit.....	14
5.2. Test Setup.....	14
5.3. Test Procedure.....	14
5.4. Test Condition.....	15
5.5. Test Data.....	15
6. Electrostatic Discharge Immunity Test.....	18
6.1. Test Requirements.....	18
6.2. Test Setup.....	18
6.3. Test Procedure.....	19
6.4. Test Data.....	19
7. Radiated Electromagnetic Field Immunity Test.....	21
7.1. Test Requirements.....	21
7.2. Test Setup.....	21
7.3. Test Procedure.....	21
7.4. Test Data.....	22
8. Photographs - Constructional Details.....	24

1. General Information

1.1. Client Information

Applicant	:	Xingzhiguang Tech (Shenzhen) Co., Ltd.
Address	:	7 Floor, Economic Building of Huafeng, Xixiang Town, Bao'an District, Shenzhen, China.
Manufacturer	:	Xingzhiguang Tech (Shenzhen) Co., Ltd.
Address	:	7 Floor, Economic Building of Huafeng, Xixiang Town, Bao'an District, Shenzhen, China.

1.2. General Description of EUT (Equipment Under Test)

EUT Name	:	Dog Training Collar
Model No.	:	DOG
Serial No.	:	DOG100, DOG200, DOG200S, DOG200SA, DOG200A, DOG300, DOG300B, DOGQ20, DOGQ20A, DOGA60, DOGA90, A10, A20, A70, A80, A50
Trademark	:	N/A
Power Supply	:	DC 3V, 300mA
Remark: All above models are identical in schematic, structure and critical components except for only different appearance; therefore, EMC testing was performed with DOG only.		

1.3. Block Diagram Showing The Configuration of System Tested

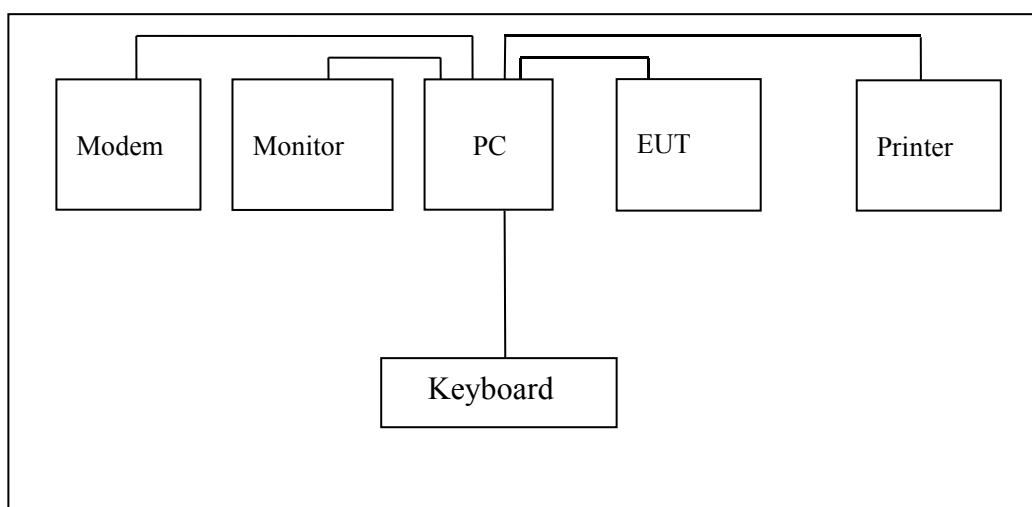

1.4. Description of Support Units

Name	Model	S/N	Manufacturer	Used “√”
Printer	HP1505n	VNF3G06957	HP	√
Modem	RX304Xv2	----	ASUS	√
LCD Monitor	E170Sc	----	DELL	√
PC	OPTIPLEX380	----	DELL	√
Keyboard	L100	U01C	DELL	√

1.5. Performance Criterion

Criterion A: The equipment shall continue to operate as intended without operator intervention. No degradation of performance or loss of function is allowed below a performance level specified by the manufacturer when the equipment is used as intended.

Criterion B: After the test, the equipment shall continue to operate as intended without operator intervention. No degradation of performance or loss of function is allowed, after the application of the phenomena below a performance level specified by the manufacturer, when the equipment is used as intended.

Criterion C: Loss of function is allowed, provided the function is self-recoverable, or can be restored by the operation of the controls by the user in accordance with the manufacturer's instructions.

1.6. Test Facility

The testing report were performed by the Shenzhen HX Detect Certification Co., Ltd., in their facilities located at 2/F, bostai, building 22, Tangxi Yongli Industrial Zone, guxing community, Xixiang street, Bao'an District, Shenzhen.

2. TEST Results Summary

EMISSION		
Description of test items	Standards	Results
Conducted disturbance at mains terminals	EN 55032: 2015/A1: 2020	N/A
Radiated Disturbance	EN 55032: 2015/A1: 2020	Pass
Harmonic current emissions	EN IEC 61000-3-2: 2019/A1: 2021	N/A
Voltage fluctuation and flicker	EN 61000-3-3:2013/A1:2019	N/A
IMMUNITY		
Description of test items	Standards	Results
Electrostatic Discharge (ESD)	EN 61000-4-2: 2009	Pass
Radio-frequency, Continuous radiated disturbance	EN IEC 61000-4-3:2020	Pass
EFT/B Immunity	EN 61000-4-4: 2012	N/A
Surge Immunity	EN 61000-4-5: 2014/A1:2017	N/A
Conducted RF Immunity	EN 61000-4-6: 2014	N/A
Power frequency magnetic field	EN 61000-4-8: 2010	N/A
Voltage dips, >95% reduction	EN IEC 61000-4-11:2020	N/A
Voltage dips, 30% reduction		
Voltage interruptions		
Note: N/A is an abbreviation for Not Applicable.		

3. Test Equipment Used

3.1. Test Equipment Used to Measure Conducted Emission					
No.	Equipment	Manufacturer	Model No.	Last Cal.	Cal. Interval
HX-EMC001	EMI Test Receiver	Rohde & Schwarz	ESCS30	Jan. 04, 2021	1 Year
HX-EMC002	AMN	Rohde & Schwarz	ENV216	Jan. 04, 2021	1 Year
HX-EMC003	AMN	SCHWARZBECK	NNBL 8226	Jan. 04, 2021	1 Year
3.2. Test Equipment Used to Measure Radiated Emission					
No.	Equipment	Manufacturer	Model No.	Last Cal.	Cal. Interval
HX-EMC004	EMI Test Receiver	Rohde & Schwarz	ESI26	Jan. 04, 2021	1 Year
HX-EMC005	Bilog Antenna	SCHWARZBECK	VULB9163	Jan. 04, 2021	1 Year
HX-EMC006	Positioning Controller	C&C	CC-C-1F	N/A	N/A
3.3. Test Equipment Used to Measure Harmonic Current/ Voltage Fluctuation and Flicker					
No.	Equipment	Manufacturer	Model No.	Last Cal.	Cal. Interval
HX-EMC007	Harmonic Flicker Test System	CI	5001ix-CTS-400	Jan. 04, 2021	1 Year
3.4. Test Equipment Used to Measure Electrostatic Discharge Immunity					
No.	Equipment	Manufacturer	Model No.	Last Cal.	Cal. Interval
HX-EMC008	ESD Tester	TESEQ	NSG437	Jan. 04, 2021	1 Year
3.5. Test Equipment Used to Measure Conducted Immunity					
No.	Equipment	Manufacturer	Model No.	Last Cal.	Cal. Interval
HX-EMC009	RF Generator	FRANKONIA	CIT-10/75	Jan. 04, 2021	1 Year
HX-EMC009	RF Generator	FRANKONIA	CIT-10/75	Jan. 04, 2021	1 Year
HX-EMC011	M-CDN	LUTHI	M2/M3	Jan. 04, 2021	1 Year
HX-EMC012	CDN	LUTHI	AF2	Jan. 04, 2021	1 Year
HX-EMC013	EM Injection Clamp	LUTHI	EM101	Jan. 04, 2021	1 Year
3.6. Test Equipment Used to Measure Radio Frequency Electromagnetic Fields Immunity					
No.	Equipment	Manufacturer	Model No.	Last Cal.	Cal. Interval
HX-EMC014	Signal Generator	Rohde & Schwarz	SMT03	Jan. 04, 2021	1 Year

HX-EMC015	Power Meter	Rohde & Schwarz	NRVD	Jan. 04, 2021	1 Year
HX-EMC016	Voltage Probe	Rohde & Schwarz	URV5-Z2	Jan. 04, 2021	1 Year
HX-EMC017	Voltage Probe	Rohde & Schwarz	URV5-Z2	Jan. 04, 2021	1 Year
HX-EMC018	Power Amplifier	AR	150W1000	Jan. 04, 2021	1 Year
HX-EMC019	Bilog Antenna	Chase	CBL6111C	Jan. 04, 2021	1 Year

3.7. Test Equipment Used to Measure Electrical Fast Transient/Burst Immunity

No.	Equipment	Manufacturer	Model No.	Last Cal.	Cal. Interval
HX-EMC020	Simulator	EMTEST	UCS500N5	Jan. 04, 2021	1 Year
HX-EMC021	Auto-transformer	EMTEST	V4780S2	Jan. 04, 2021	1 Year

3.8. Test Equipment Used to Measure Surge Immunity

No.	Equipment	Manufacturer	Model No.	Last Cal.	Cal. Interval
HX-EMC022	Simulator	EMTEST	UCS500N5	Jan. 04, 2021	1 Year
HX-EMC023	Coupling Clamp	EMTEST	HFK	Jan. 04, 2021	1 Year

3.9. Test Equipment Used to Measure Voltage Dips and Interruptions Immunity

No.	Equipment	Manufacturer	Model No.	Last Cal.	Cal. Interval
HX-EMC022	Simulator	EMTEST	UCS500N5	Jan. 04, 2021	1 Year
HX-EMC023	Coupling Clamp	EMTEST	HFK	Jan. 04, 2021	1 Year

3.10. Test Equipment Used to Measure Power frequency Magnetic Field

No.	Equipment	Manufacturer	Model No.	Last Cal.	Cal. Interval
HX-EMC026	Power Frequency Magnetic Field Generator	EVERFINE	EMS61000-8	Jan. 04, 2021	1 Year

4. Conducted Emission Test

4.1. Test Standard and Limit

4.1.1. Test Standard

EN 55032: 2015/A1: 2020.

4.1.2. Test Limit

Conducted Disturbance Test Limit (Class B)

Frequency	Maximum RF Line Voltage (Db μ V)	
	Quasi-peak Level	Average Level
150kHz~500kHz	66 ~ 56 *	56 ~ 46 *
500kHz~5MHz	56	46
5MHz~30MHz	60	50

4.2. Test Setup

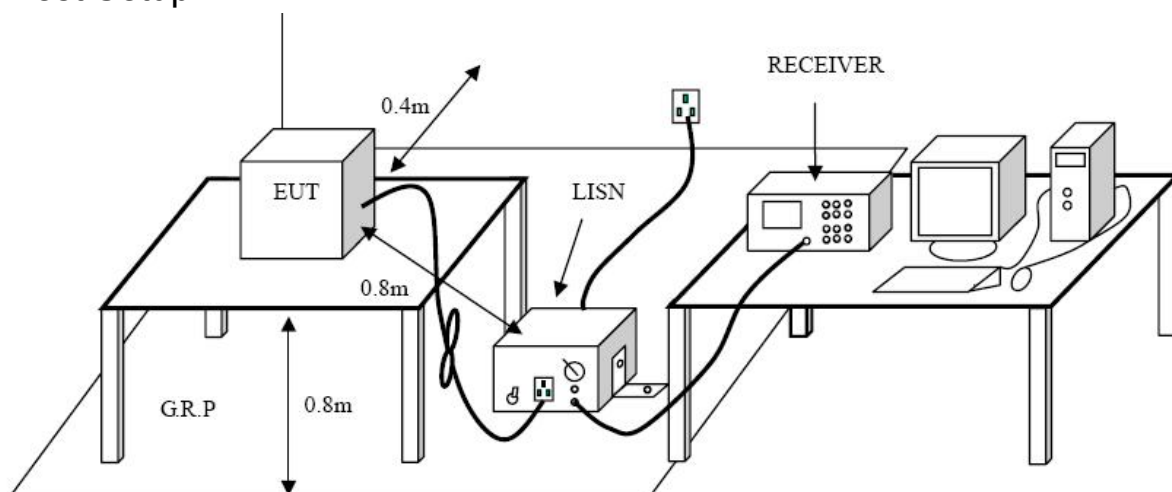

4.3. Test Procedure

The EUT was placed 0.8 meters from the horizontal ground plane with EUT being connected to the power mains through a line impedance stabilization network (LISN). All other support equipments powered from additional LISN(s). The LISN provide 50 Ohm/ 50U_h of coupling impedance for the measuring instrument.

Interconnecting cables that hang closer than 40 cm to the ground plane shall be folded back and forth in the center forming a bundle 30 to 40 cm long.

I/O cables that are not connected to a peripheral shall be bundled in the center. The end of the cable may be terminated, if required, using the correct terminating impedance. The overall length shall not exceed 1 m.

LISN at least 80 cm from nearest part of EUT chassis.
The bandwidth of EMI test receiver is set at 9kHz, and the test frequency band is from 0.15MHz to 30MHz.

4.4. Test Condition

Temperature	:	25 °C
Relative Humidity	:	48 %
Pressure	:	1010 hPa
Test Power	:	DC 3V

4.5. Test Data

Please refer to the following pages.

Operating Condition: Normal

Test Specification: Line

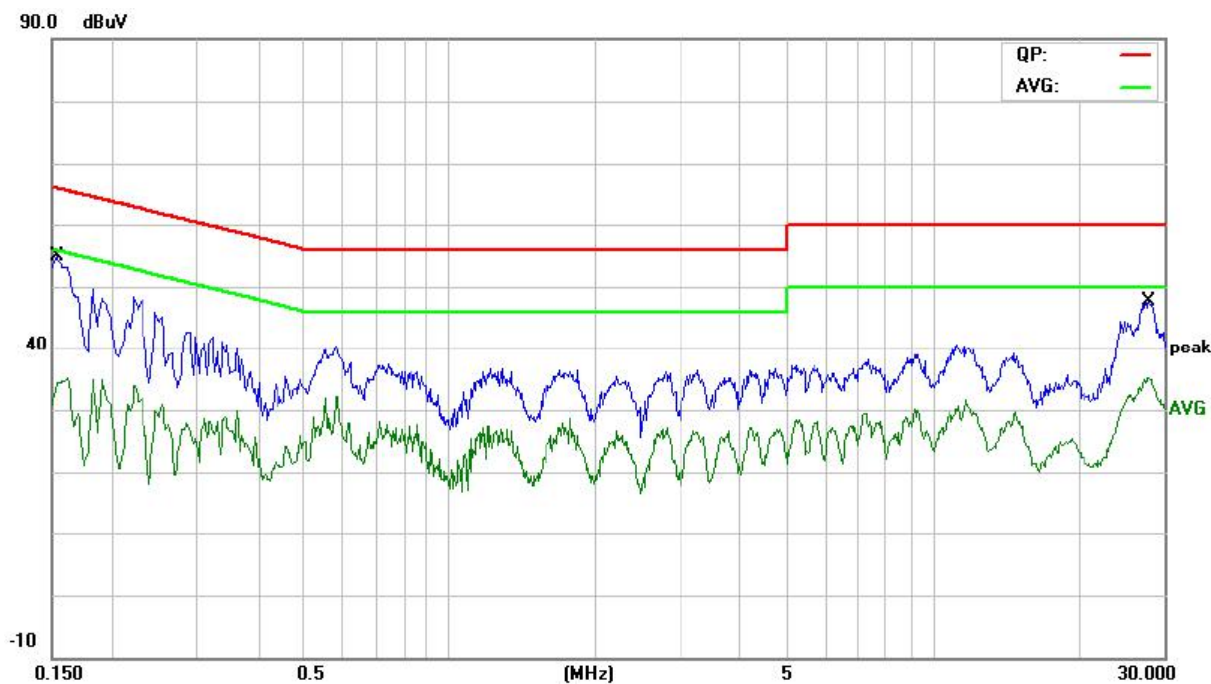

No.	Mk.	Freq. MHz	Reading Level dBuV	Correct Factor dB	Measure- ment dBuV	Limit dBuV	Over dB	Detector	Comment
1	*	0.1539	41.29	10.85	52.14	65.78	-13.64	QP	
2		0.1539	24.12	10.85	34.97	55.78	-20.81	AVG	
3		27.8980	30.35	10.10	40.45	60.00	-19.55	QP	
4		27.8980	22.88	10.10	32.98	50.00	-17.02	AVG	

Operating Condition: Normal

Test Specification: Neutral

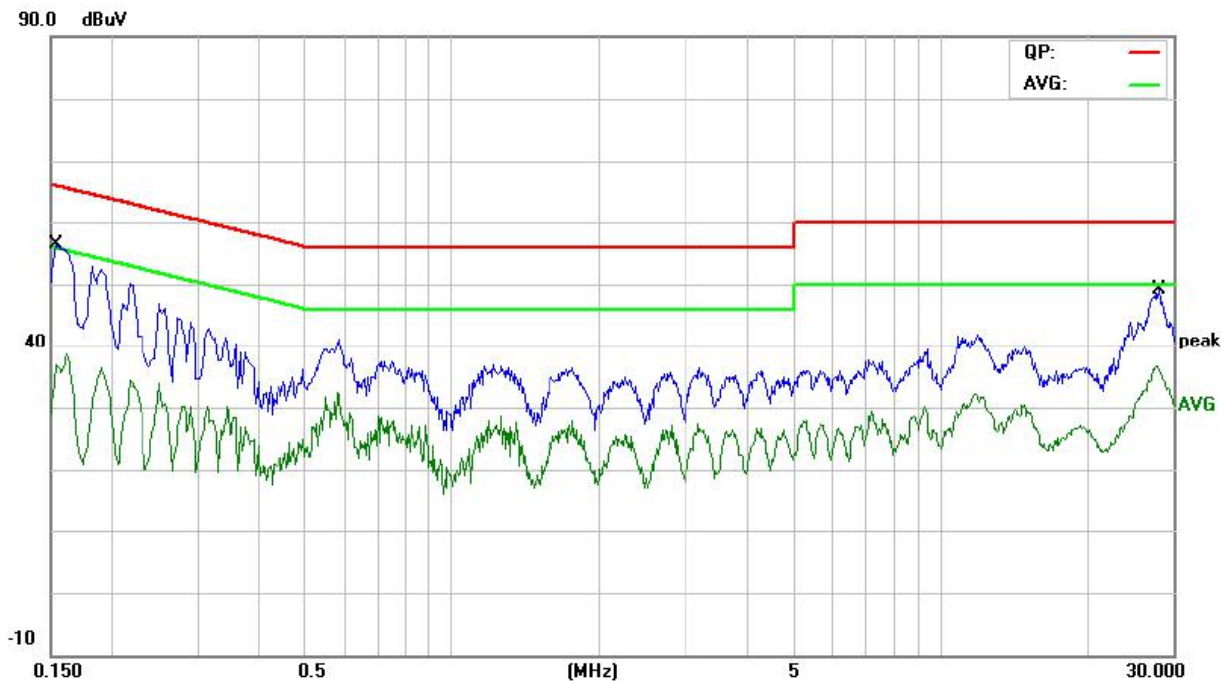

No.	Mk.	Freq. MHz	Reading Level dBuV	Correct Factor dB	Measure- ment dBuV	Limit dBuV	Over dB	Detector	Comment
1	*	0.1539	42.15	10.88	53.03	65.78	-12.75	QP	
2		0.1539	24.64	10.88	35.52	55.78	-20.26	AVG	
3		28.1380	32.08	10.12	42.20	60.00	-17.80	QP	
4		28.1380	24.44	10.12	34.56	50.00	-15.44	AVG	

Operating Condition: Normal (PC)

Test Specification: Line

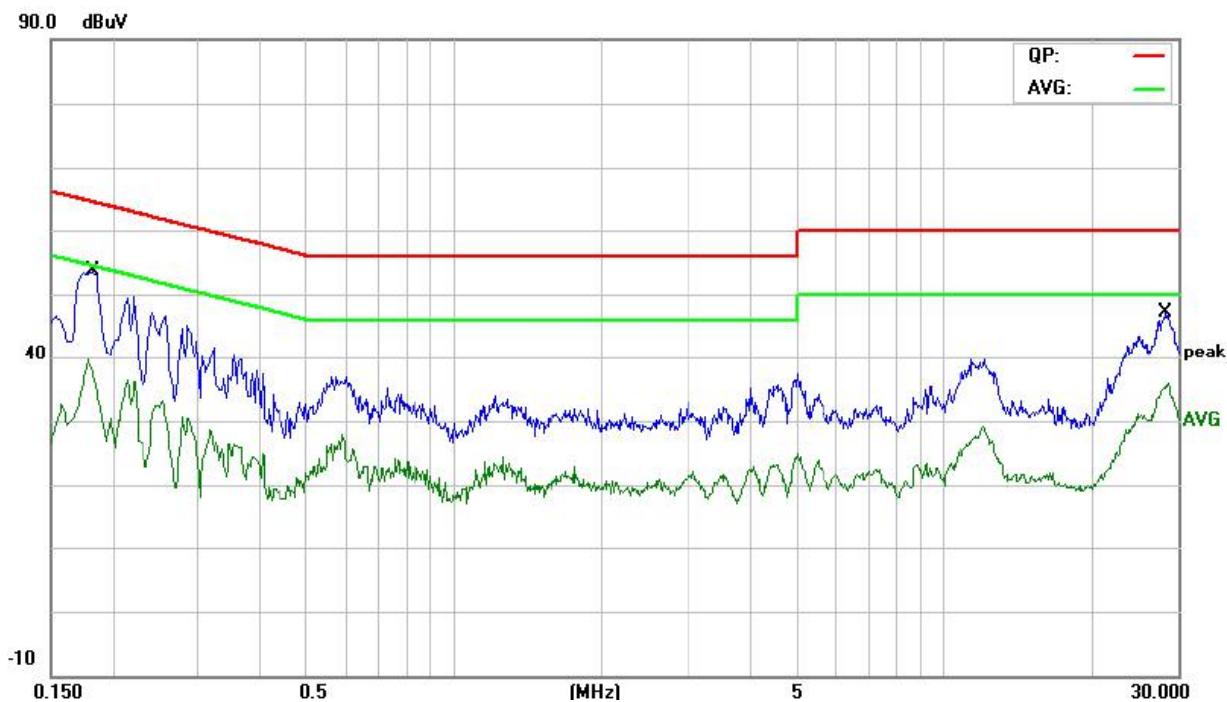

No.	Mk.	Freq. MHz	Reading Level dBuV	Correct Factor dB	Measure- ment dBuV	Limit dBuV	Over dB	Detector	Comment
1	*	0.1819	39.66	10.53	50.19	64.39	-14.20	QP	
2		0.1819	24.33	10.53	34.86	54.39	-19.53	AVG	
3		28.3780	28.78	10.12	38.90	60.00	-21.10	QP	
4		28.3780	22.47	10.12	32.59	50.00	-17.41	AVG	

Operating Condition: Normal (PC)

Test Specification: Neutral

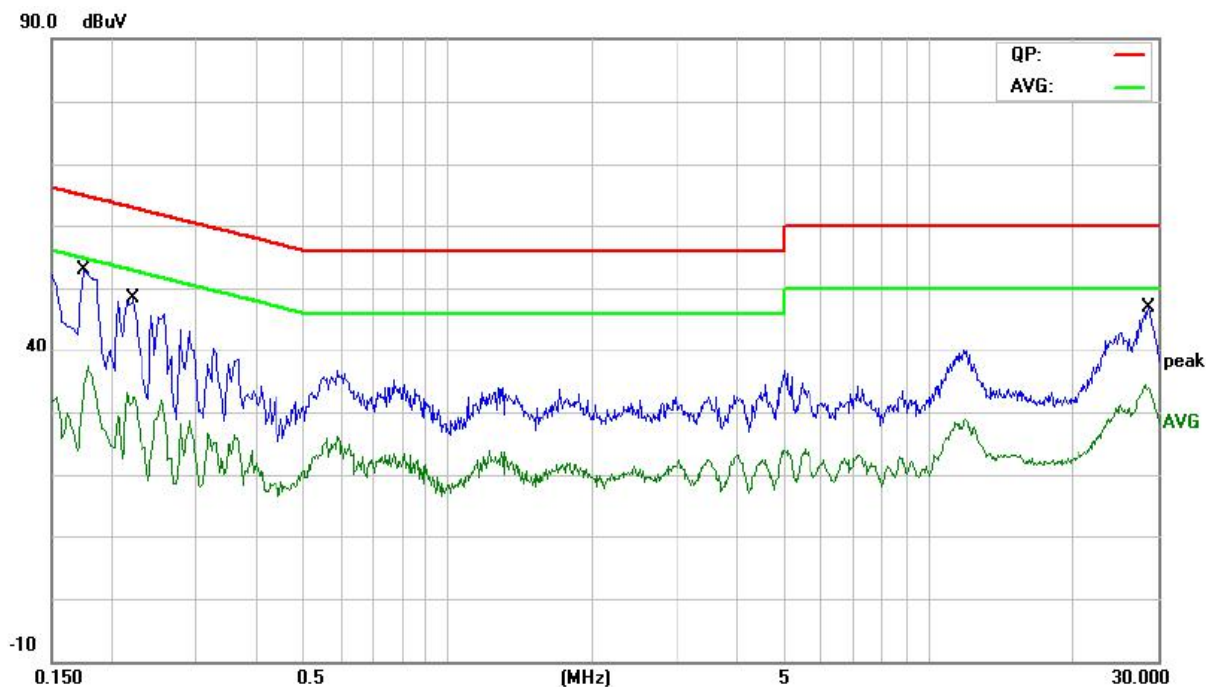

No.	Mk.	Freq. MHz	Reading Level dBuV	Correct Factor dB	Measure- ment dBuV	Limit dBuV	Over dB	Detector	Comment
1	*	0.1740	37.89	10.65	48.54	64.76	-16.22	QP	
2		0.1740	19.75	10.65	30.40	54.76	-24.36	AVG	
3		0.2220	34.00	10.19	44.19	62.74	-18.55	QP	
4		0.2220	19.14	10.19	29.33	52.74	-23.41	AVG	
5		28.6540	29.48	10.18	39.66	60.00	-20.34	QP	
6		28.6540	22.36	10.18	32.54	50.00	-17.46	AVG	

5. Radiated Emission Test

5.1. Test Standard and Limit

5.1.1. Test Standard

EN 55032: 2015/A1: 2020

5.1.2. Test Limit

Radiated Disturbance Test Limit (Class B)

Frequency	Limit (dB μ V/m)
	Quasi-peak Level
30MHz~230MHz	40
230MHz~1000MHz	47

Remark: 1. The lower limit shall apply at the transition frequency.
2. The test distance is 3m.

5.2. Test Setup

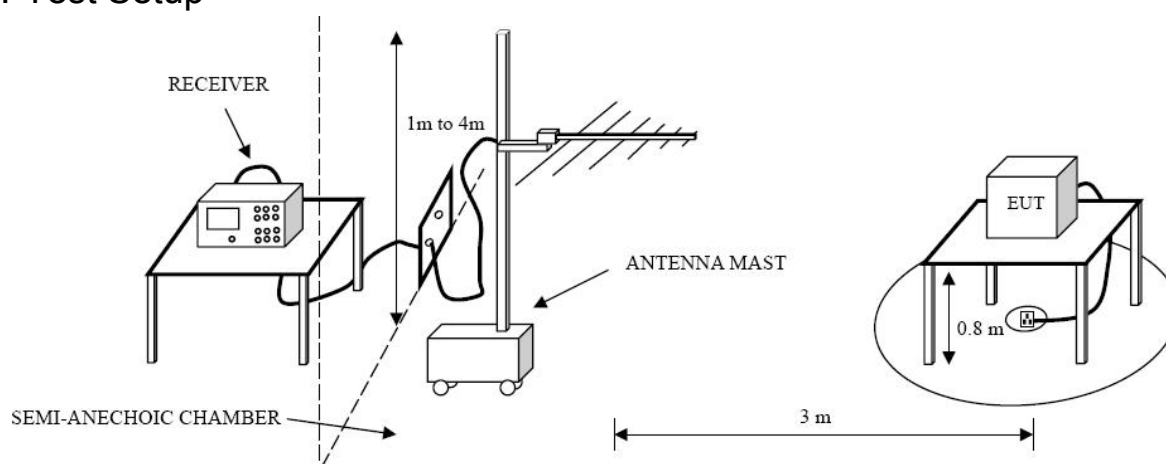

5.3. Test Procedure

The EUT was placed on the top of a rotating table 0.8 meters above the ground at a 3m. The table was rotated 360 degrees to determine the position of the highest radiation.

The height of the equipment or of the substitution antenna shall be 0.8 m; the height of the test antenna shall vary between 1 m to 4 m. Both horizontal and vertical polarizations of the antenna are set to make the measurement.

The initial step in collecting radiated emission data is a spectrum analyzer peak detector mode pre-scanning the measurement frequency range.

If the Peak Mode measured value compliance with and lower than Quasi Peak Mode Limit, the EUT shall be deemed to meet QP Limits and then no additional QP Mode measurement performed.

5.4. Test Condition

Temperature	:	25 °C
Relative Humidity	:	48 %
Pressure	:	1010 hPa
Test Power	:	DC 3V

5.5. Test Data

Please refer to the following pages.

Operating Condition: Normal
Test Specification: Horizontal



No.	Mk.	Freq. MHz	Reading Level dBuV	Correct Factor dBuV/m	Measure- ment dBuV/m	Limit dBuV/m	Over dB	Detector
1		122.8340	36.36	-16.02	20.34	40.00	-19.66	peak
2		155.3643	40.93	-17.02	23.91	40.00	-16.09	peak
3		239.1473	42.03	-12.77	29.26	47.00	-17.74	peak
4		370.7022	32.82	-9.82	23.00	47.00	-24.00	peak
5		672.8444	35.77	-4.90	30.87	47.00	-16.13	peak
6	*	962.1622	33.50	-2.00	31.50	47.00	-15.50	peak

Operating Condition: Normal
Test Specification: Vertical



No.	Mk.	Freq. MHz	Reading Level dBuV	Correct Factor dBuV/m	Measure- ment dBuV/m	Limit dBuV/m	Over dB	Detector
1		32.7486	44.08	-13.89	30.19	40.00	-9.81	peak
2		58.6126	37.40	-12.80	24.60	40.00	-15.40	peak
3		98.8324	36.72	-13.99	22.73	40.00	-17.27	peak
4	*	223.7333	44.29	-13.18	31.11	40.00	-8.89	peak
5		672.8444	37.19	-4.90	32.29	47.00	-14.71	peak
6		962.1622	37.39	-2.00	35.39	47.00	-11.61	peak

6. Electrostatic Discharge Immunity Test

6.1. Test Requirements

6.1.1. Test Standard

EN 55035:2017/A11:2020 (EN 61000-4-2: 2009)

6.1.2. Test Level

Level	Test Voltage Contact Discharge (kV)	Test Voltage Air Discharge (kV)
1	±2	±2
2	±4	±4
3	±6	±8
4	±8	±15
X	Special	Special

6.1.3. Performance criterion: **B**

6.2. Test Setup

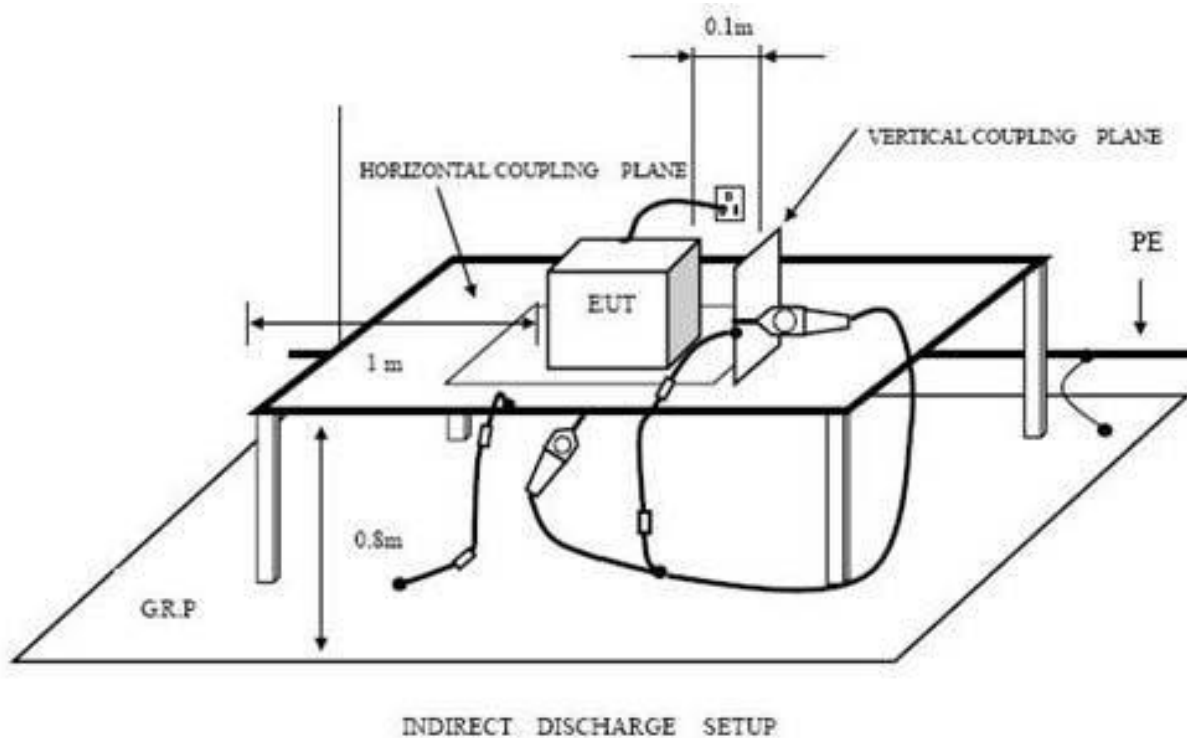

6.3. Test Procedure

6.3.1. Air Discharge:

This test is done on a non-conductive surface. The round discharge tip of the discharge electrode shall be approached as fast as possible to touch the EUT. After each discharge, the discharge electrode shall be removed from the EUT. The generator is then re-triggered for a new single discharge and repeated 10 times for each pre-selected test point. This procedure shall be repeated until all the air discharge completed.

6.3.2. Contact Discharge:

All the procedure shall be same as air discharge. Except that the tip of the discharge electrode shall touch the EUT before the discharge switch is operated.

6.3.3. Indirect discharge for horizontal coupling plane

At least 10 single discharges (in the most sensitive polarity) shall be applied at the front edge of each HCP opposite the center point of each unit (if applicable) of the EUT and 0.1m from the front of the EUT. The long axis of the discharge electrode shall be in the plane of the HCP and perpendicular to its front edge during the discharge.

6.3.4. Indirect discharge for vertical coupling plane

At least 10 single discharges (in the most sensitive polarity) shall be applied to the center of one vertical edge of the coupling plane. The coupling plane, of dimensions 0.5m X 0.5m, is placed parallel to, and positioned at a distance of 0.1m from the EUT. Discharges shall be applied to the coupling plane, with this plane in sufficient different positions that the four faces of the EUT are completely illuminated.

6.4. Test Data

Please refer to the following pages.

Electrostatic Discharge Test Result

EUT : <u>Dog Training Collar</u> M/N : <u>DOG</u>		
Temperature : <u>22°C</u> Humidity : <u>50%</u>		
Power supply : <u>DC 3V</u> Test Mode : <u>Normal</u>		
Criterion: B		
Air Discharge: $\pm 8\text{kV}$ Contact Discharge: $\pm 4\text{kV}$		
For each point positive 10 times and negative 10 times discharge.		
Location	Kind A-Air Discharge C-Contact Discharge	Result
Nonconductive Enclosure	A	PASS
Slot of the EUT	A	PASS
USB Port	A	PASS
LED Light	A	PASS
HCP	C	PASS
VCP of front	C	PASS
VCP of rear	C	PASS
VCP of left	C	PASS
VCP of right	C	PASS

7. Radiated Electromagnetic Field Immunity Test

7.1. Test Requirements

7.1.1. Test Standard

EN 55035:2017/A11:2020 (EN IEC 61000-4-3:2020)

7.1.2. Test Level

Level	Field Strength V/m
1	1
2	3
3	10
X	Special

7.1.3. Performance criterion: A

7.2. Test Setup

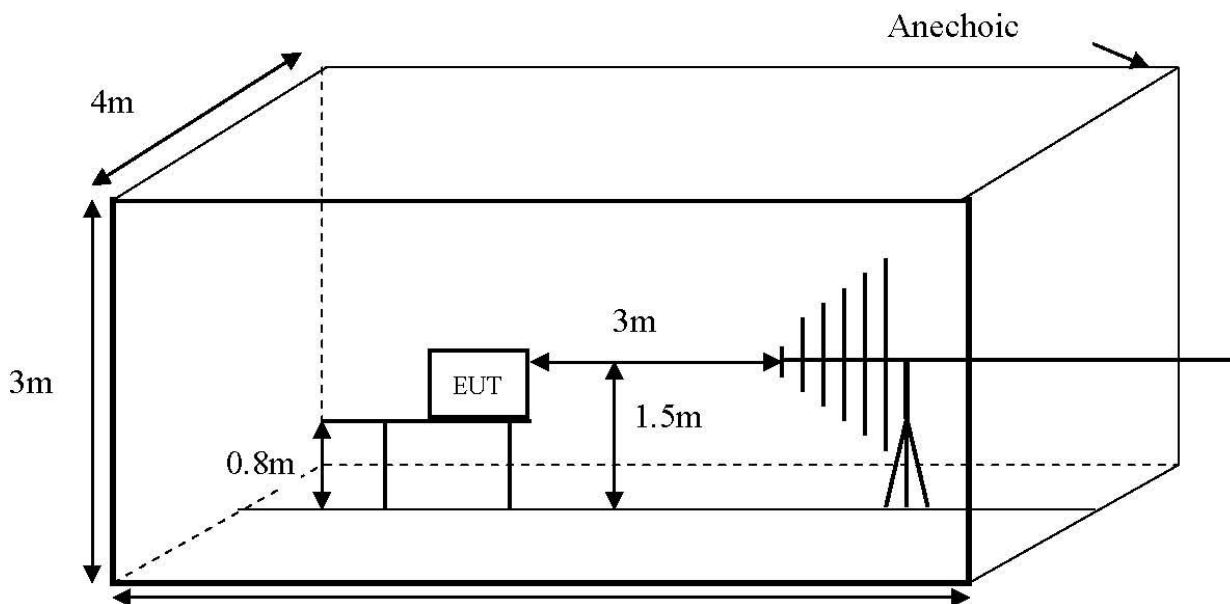

7.3. Test Procedure

The EUT are placed on a table, which is 0.8 meter high above the ground. The EUT is set 3 meters away from the transmitting antenna, which is mounted on an antenna tower. Both horizontal and vertical polarization of the antenna is set on test. Each of the four sides of the EUT must be faced this transmitting antenna and measured individually.

In order to judge the EUT performance, a camera is used to monitor its screen.

All the scanning conditions are as following:

Condition of Test	Remark
Fielded strength	3V/m (Severity Level 2)
Radiated signal	Modulated
Scanning frequency	80-1000MHz
Sweep time of radiated	0.0015 Decade/s
Dwell time	1 Sec.

7.4. Test Data

Please refer to the following pages.

RF Field Strength Susceptibility Test Results

EUT : <u>Dog Training Collar</u> M/N : <u>DOG</u>				
Temperature : <u>22°C</u> Humidity : <u>50%</u>				
Power supply : <u>DC 3V</u> Test Mode : <u>Normal</u>				
Criterion: A				
Modulation: Unmodulated				
Pulse: AM 1KHz 80%				
	Frequency Range 1		Frequency Range 2	
	80~1000MHz			
	Horizontal	Vertical	Horizontal	Vertical
Front	PASS	PASS	/	/
Right	PASS	PASS	/	/
Rear	PASS	PASS	/	/
Left	PASS	PASS	/	/
Remark:				

8. Photographs - Constructional Details

Photo 1 Appearance of EUT



Photo 2 Appearance of EUT



Photo 3 inside of EUT



Photo 4 Appearance of PCB

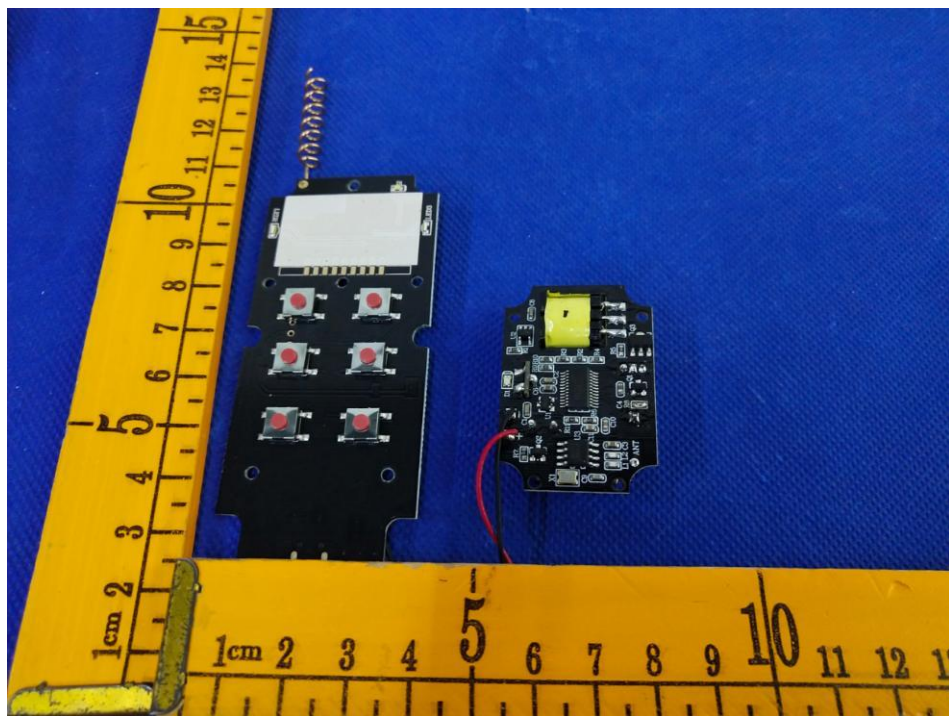
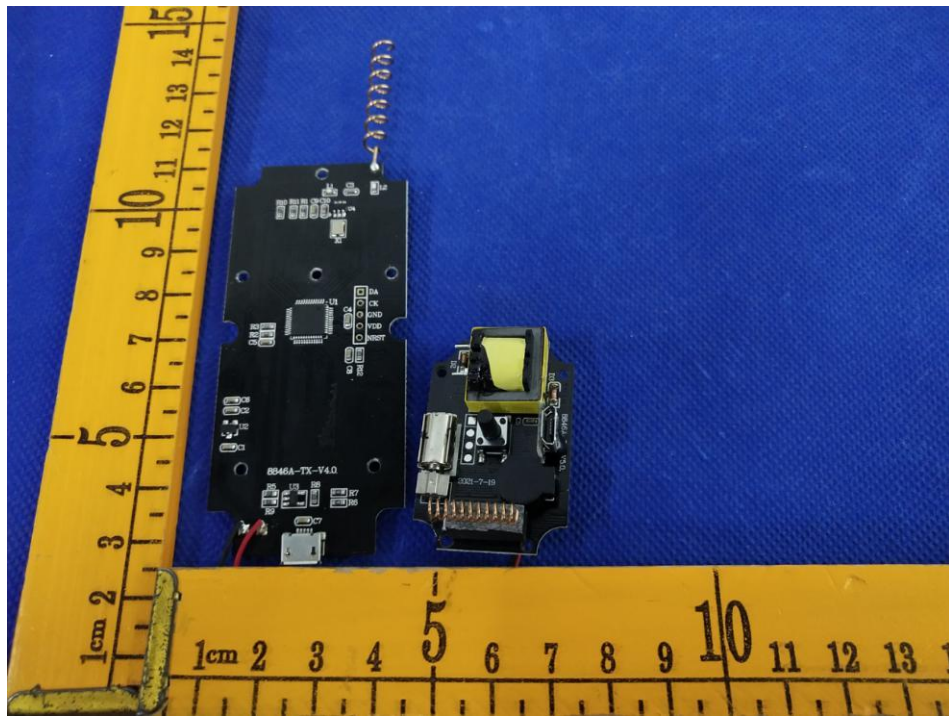

Photo 5 Appearance of PCB



END OF REPORT